

# HIGH TEMPERATURE ADJUSTABLE PRECISION ZENER SHUNT REGULATOR

## ZHT2431

ISSUE 1 JULY 1997

### DEVICE DESCRIPTION

The ZHT2431 is a three terminal adjustable shunt regulator offering excellent temperature stability and output current handling capability up to 25mA. The output voltage may be set to any chosen voltage between 1.24 and 15 volts by selection of two external divider resistors.

The devices can be used as a replacement for zener diodes in many applications requiring an improvement in zener performance.

The ZHT2431 is particularly used in the feedback control loop of switch mode power supplies. In this application the device 1.24 volt reference enables the generation of low voltage supplies, typically 3.3 volts or 3 volts.

The ZHT2431 is intended for use over the extended operating range of -55°C to 125°C.

### FEATURES

- Surface mount SOT23 package
- TO92 package
- 2.5% tolerance
- Average temperature coefficient 50 ppm/°C
- Temperature compensated for operation over the full temperature range
- Programmable output voltage
- 100µA to 25mA current sink capability
- Low output noise
- -55° to 125° C operation

### APPLICATIONS

- Shunt regulator
- Series regulator
- Voltage monitor
- Over voltage/ under voltage protection
- Switch mode power supplies

### SCHEMATIC DIAGRAM

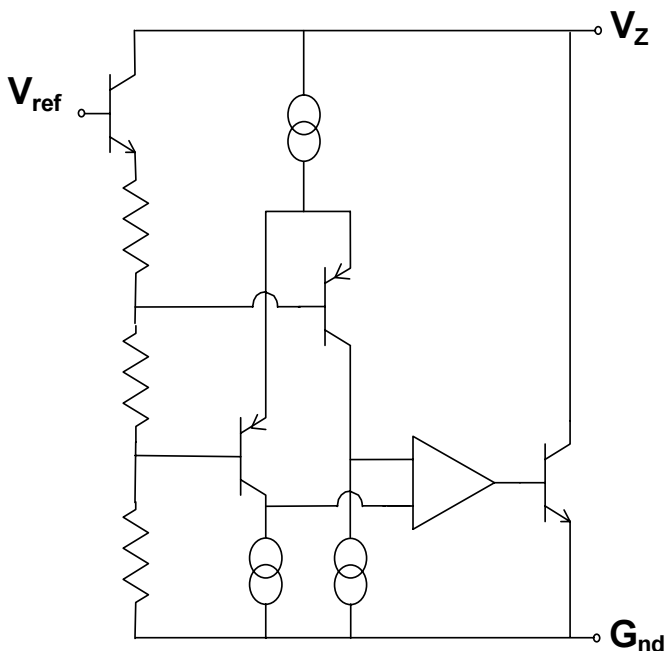

# ZHT2431

## ABSOLUTE MAXIMUM RATING

Cathode Voltage (V <sub>Z</sub> )	15V
Cathode Current	50mA
Operating Temperature	-55 to 125°C
Storage Temperature	-55 to 125°C

Power Dissipation (T<sub>amb</sub>=25°C, T<sub>jmax</sub>=150°C)

SOT23	330mW
TO92	780mW

## Recommended Operating Conditions

Cathode Voltage (min)V <sub>REF</sub> to (max) 15V
Cathode Current (min) 100μA to (max) 25mA

## ELECTRICAL CHARACTERISTICS

TEST CONDITIONS (Unless otherwise stated): T<sub>amb</sub>=25°C

PARAMETER	SYMBOL	VALUE			UNITS	CONDITIONS
		MIN	TYP	MAX		
Reference Voltage 2.5%	V <sub>ref</sub>	1.21	1.24	1.27	V	I <sub>L</sub> =10mA (Fig1), V <sub>Z</sub> =V <sub>ref</sub>
Deviation of Reference Input Voltage over Temperature	V <sub>dev</sub>		5.0	15.0	mV	I <sub>L</sub> =10mA, V <sub>Z</sub> =V <sub>ref</sub> T <sub>a</sub> =full range (Fig1)
Ratio of the change in Reference Voltage to the Change in Cathode Voltage	$\frac{\Delta V_{ref}}{\Delta V_Z}$		0.5	2.0	mV/V	V <sub>Z</sub> from V <sub>ref</sub> to 10V I <sub>Z</sub> =10mA (Fig2)
Reference Input Current	I <sub>ref</sub>	0.02	0.11	0.4	μA	R1=10K, R2=0/C, I <sub>L</sub> =10mA (Fig2)
Deviation of Reference Input Current over Temperature	ΔI <sub>ref</sub>		0.02	0.2	μA	R1=10K, R2=0/C, I <sub>L</sub> =10mA T <sub>a</sub> =full range (Fig2)
Minimum Cathode Current for Regulation	I <sub>Zmin</sub>		30	100	μA	†
Off-state Current	I <sub>Zoff</sub>		10	30	μA	V <sub>Z</sub> =15V, V <sub>ref</sub> =0V (Fig3)
Dynamic Output Impedance	R <sub>Z</sub>		0.25	2	Ω	V <sub>Z</sub> =V <sub>ref</sub> (Fig1), f=0Hz, I <sub>L</sub> =10mA

Deviation of reference input voltage, V<sub>dev</sub>, is defined as the maximum variation of the reference input voltage over the full temperature range.

The average temperature coefficient of the reference input voltage, V<sub>ref</sub> is defined as:

$$V_{ref} (ppm/^{\circ}C) = \frac{V_{dev} \times 1000000}{V_{ref} (T1 - T2)}$$

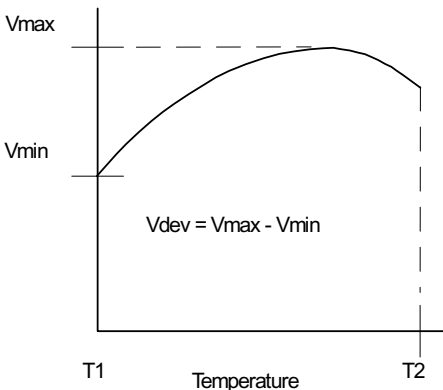

The dynamic output impedance, R<sub>Z</sub>, is defined as:

$$R_Z = \frac{\Delta V_Z}{\Delta I_Z}$$

When the device is programmed with two external resistors, R<sub>1</sub> and R<sub>2</sub>, (fig 2), the dynamic output impedance of the overall circuit, R', is defined as:

$$R' = R_Z \left( 1 + \frac{R1}{R2} \right)$$

† With a capacitance of greater than 100pF between cathode and anode, minimum cathode current must be 0.2mA.

# ZHT2431

## TYPICAL CHARACTERISTICS

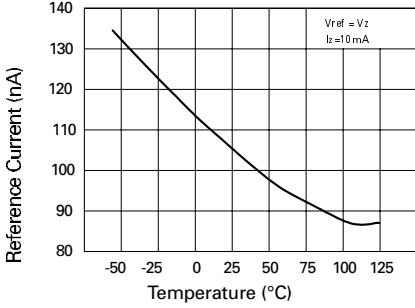

Reference Current v Temperature

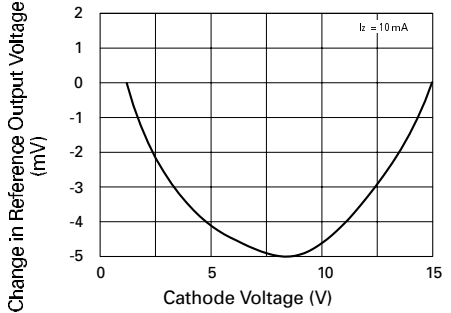

Change in  $V_{ref}$  v Cathode Voltage

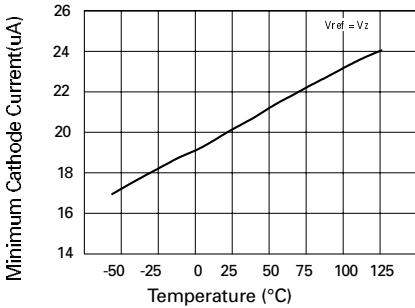

Cathode Current v Temperature

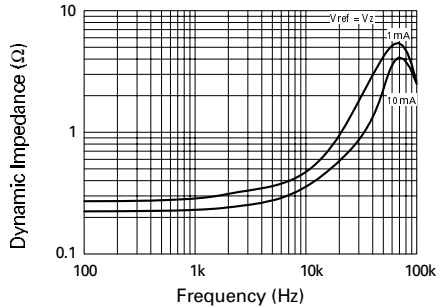

Dynamic Impedance vs. Frequency

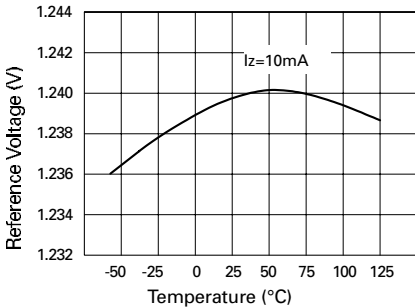

Reference Voltage v Temperature

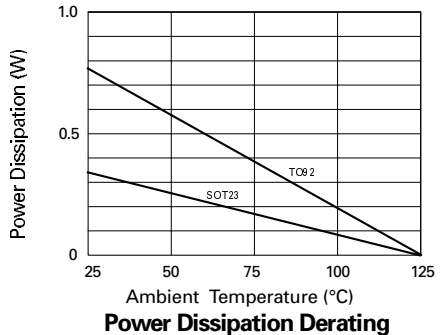

## TYPICAL CHARACTERISTICS

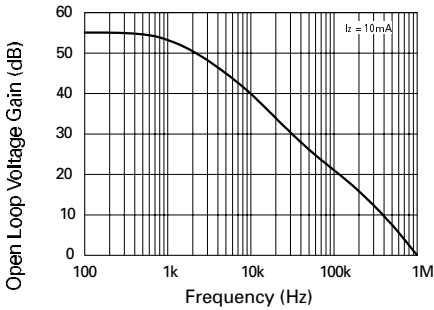

**Gain v Frequency**

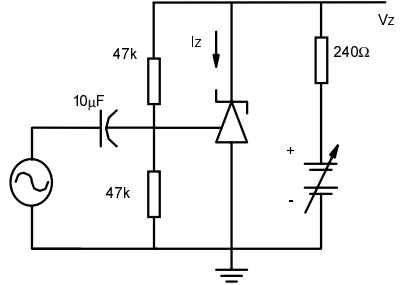

**Test Circuit for Open Loop Voltage Gain**

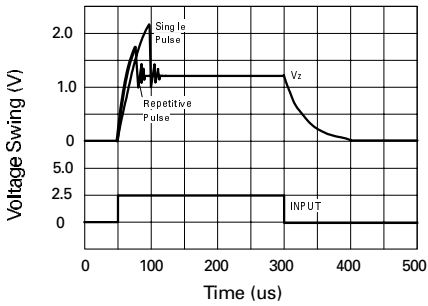

**Pulse Response**

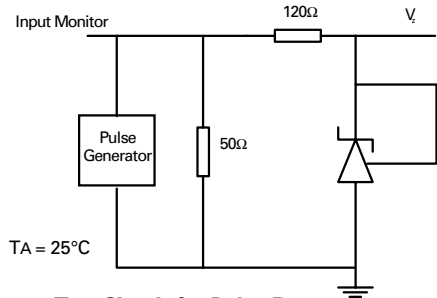

**Test Circuit for Pulse Response**

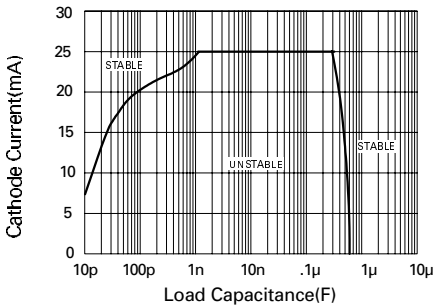

**Stability Boundary Conditions**

$V_{ref} < V_Z < 20$ ,  $I_Z = 10\text{mA}$ ,  $T_A = 25^\circ\text{C}$

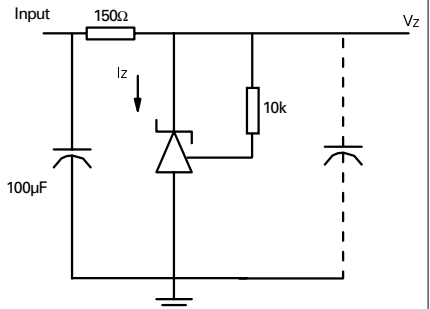

**Test Circuit for Stability Boundary Conditions**

## APPLICATION CIRCUITS

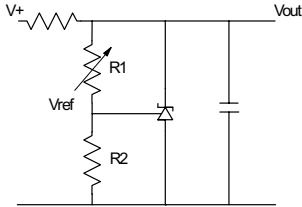

$$V_{out} = \left(1 + \frac{R1}{R2}\right) V_{ref}$$

SHUNT REGULATOR

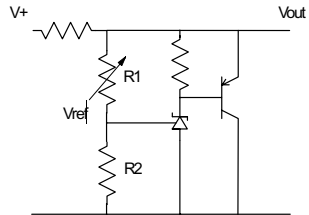

$$V_{out} = \left(1 + \frac{R1}{R2}\right) V_{ref}$$

HIGHER CURRENT SHUNT REGULATOR

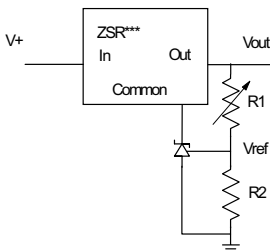

$$V_{out\_MIN} = V_{ref} + V_{reg}$$

$$V_{out} = \left(1 + \frac{R1}{R2}\right) V_{ref}$$

OUTPUT CONTROL OF A THREE TERMINAL FIXED REGULATOR

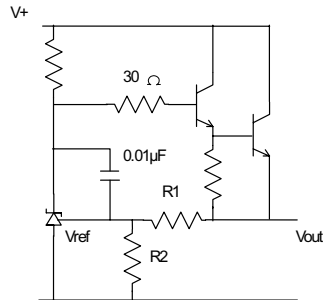

$$V_{out} = \left(1 + \frac{R1}{R2}\right) V_{ref}$$

SERIES REGULATOR

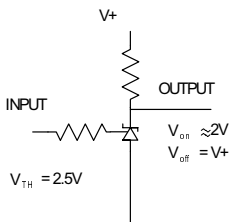

SINGLE SUPPLY COMPARATOR WITH TEMPERATURE COMPENSATED THRESHOLD

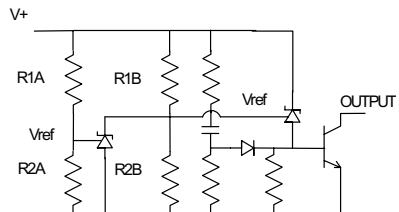

$$\text{Low limit} = \left(1 + \frac{R1B}{R2B}\right) V_{ref}$$

$$\text{High limit} = \left(1 + \frac{R1A}{R2A}\right) V_{ref}$$

OVER VOLTAGE / UNDER VOLTAGE PROTECTION CIRCUIT

# ZHT2431

## DC Test Circuits

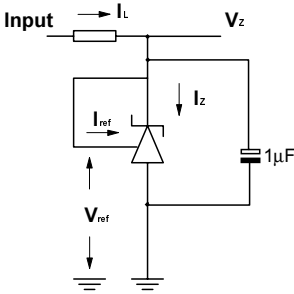

Fig 1 – Test Circuit for  $V_z = V_{ref}$

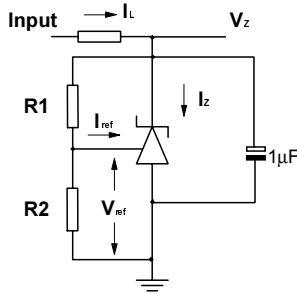

Fig 2 – Test Circuit for  $V_z > V_{ref}$

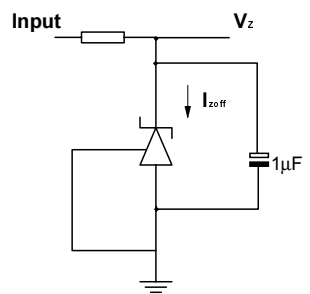
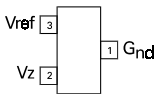

Fig 3 – Test Circuit for Off State current

## Voltage Regulator Connection Diagrams

### SOT23 Package Suffix – F



Top View

### TO92 Package Suffix – C

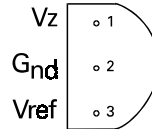

Bottom View

## Ordering Information

Part Number	Package	Part Mark
ZHT2431F02	SOT23	24F
ZHT2431C02	TO92	ZHT243102